

ISL80101 High Performance 1A LDO Evaluation Board User Guide

Description

The ISL80101 is a high performance, low voltage, high current, low dropout linear regulator specified at 1A. Rated for input voltages from 2.2V to 6V, the LDO can provide outputs from 0.8V to 5V on the adjustable version. Salient features of the part include:

- Very Fast Load Transient Response
- $\pm 1.8\%$ Guaranteed VOUT Accuracy over Line, Load and Temperature
- Typical Dropout of 130mV at 1A
- Adjustable Soft-Start and In-Rush Current Limiting
- PG Feature
- Short-Circuit and Over Temperature Protection

The ISL80101EVAL2Z provides a simple platform to evaluate performance of the ISL80101. It comes with the adjustable output version of the IC. Jumpers are provided to easily set popular output voltages. Fixed output versions are sampled in the accompanying kit.

What's Inside

The evaluation kit contains the following:

- The ISL80101EVAL2Z
- Fixed output versions of ISL80101
- The ISL80101 datasheet
- This evaluation kit document

Test Steps

1. Select the desired output voltage by shorting one of the jumpers from J1 through J6.
2. Ensure that the output capacitor and C_{PB} are set according to recommended values shown in Table 1.
3. Connect the input supply and the load.
4. Enable the IC using jumper JP1 and observe the output.

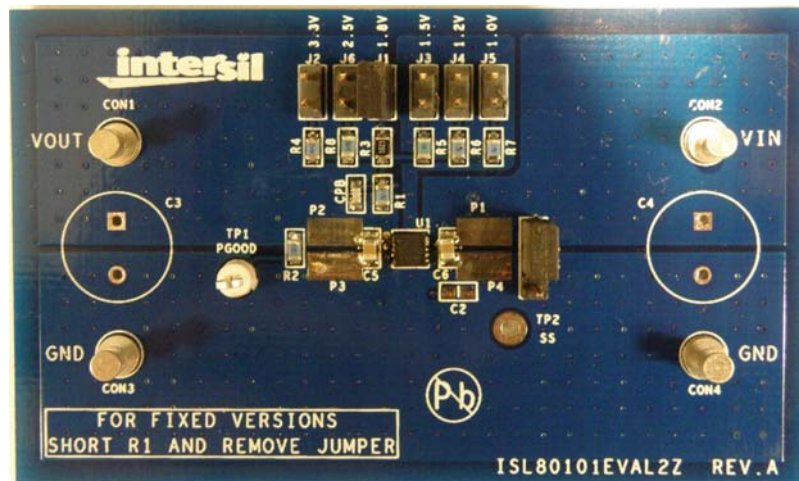

FIGURE 1. ISL80101EVAL2Z

Optimizing LDO Performance

Performance of the ISL80101 can be optimized by following these simple guidelines.

Phase Boost Capacitor (C_{PB})

On the adjustable version of the ISL80101, as shown in Figure 2, a small capacitor can be placed across the top resistor in the feedback resistor divider to place a zero at:

$$F_Z = 1 / (2 \cdot \pi \cdot R_{TOP} \cdot C_{PB}) \quad (\text{EQ. 1})$$

This zero increases the crossover frequency of the LDO and provides additional phase resulting in faster load transient response.

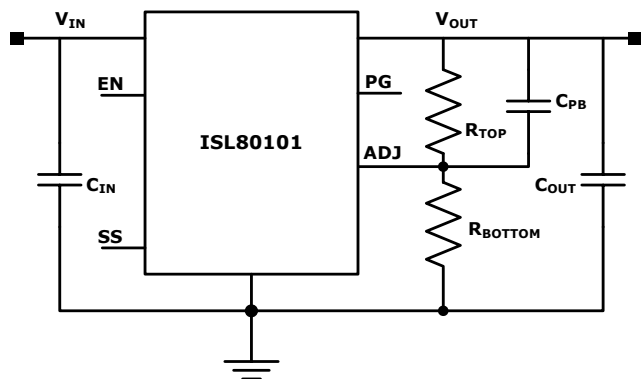

FIGURE 2. ISL80101 TYPICAL APPLICATION

Output Capacitor (C_{OUT})

Output capacitor selection is important to achieve the desired load transient performance. The ISL80101 uses state-of-the-art internal compensation to be compatible with different types of output capacitors including multi-layer ceramic, POSCAP and aluminum/tantalum electrolytic.

There is a growing trend to use very-low ESR multi-layer ceramic capacitors (MLCC) for applications because they can support fast load transients and also bypass very high frequency noise from other sources. However, effective capacitance of MLCC's drops with applied voltage, age and temperature. X7R and X5R dielectric ceramic capacitors are strongly recommended as they typically maintain a capacitance range within ±20% of nominal over full operating ratings of temperature and voltage.

Table 1 gives the recommended values for output capacitor (MLCC X5R/X7R) and C_{PB} for different voltage rails.

Right selection of output capacitor and C_{PB} also helps to increase PSRR at high frequencies.

TABLE 1.

V _{OUT} (V)	R _{TOP} (kΩ)	R _{BOTTOM} (Ω)	C _{PB} (pF)	C _{OUT} (μF)
5.0	2.61	287	100	10
3.3	2.61	464	100	10
2.5	2.61	649	82	10
1.8	2.61	1.0k	82	10
1.5*	2.61	1.3k	68	10
1.5	2.61	1.3k	150	22
1.2*	2.61	1.87k	120	22
1.2*	2.61	1.87k	270	47
1.0	2.61	2.61k	220	47
0.8	2.61	4.32k	220	47

*Either option could be used depending on cost/performance requirements.

Layout Guidelines

A good PCB layout is important to achieve expected performance. Consideration should be taken when placing the components and routing the trace to minimize the ground impedance, and keep the parasitic inductance low. The input and output capacitors should have a good ground connection and be placed as close to the IC as possible. The 'SENSE' trace in fixed voltage parts and the 'ADJ' trace in adjustable voltage parts must be away from noisy planes and traces.

Typical Performance Curves

Unless otherwise specified, $V_{IN} = V_{OUT} + 0.4V$, $V_{OUT} = 1.8V$,
 $C_{IN} = C_{OUT} = 10\mu F$, $T_J = +25^\circ C$, $I_{LOAD} = 0A$

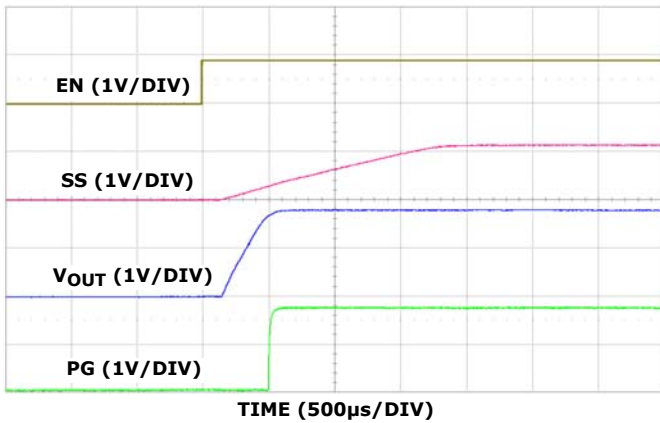

FIGURE 3. START-UP WAVEFORMS

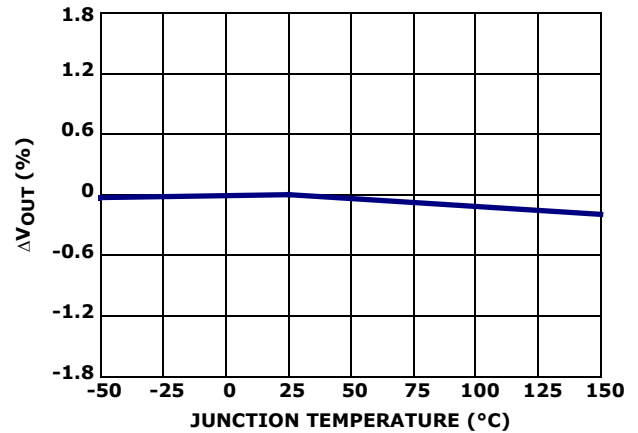

FIGURE 4. OUTPUT VOLTAGE vs TEMPERATURE

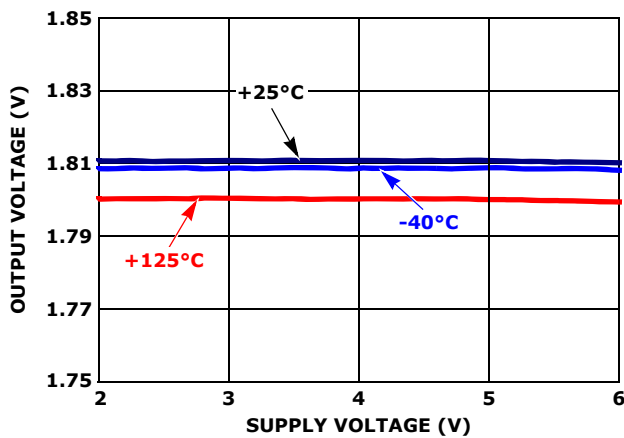

FIGURE 5. OUTPUT VOLTAGE vs INPUT VOLTAGE

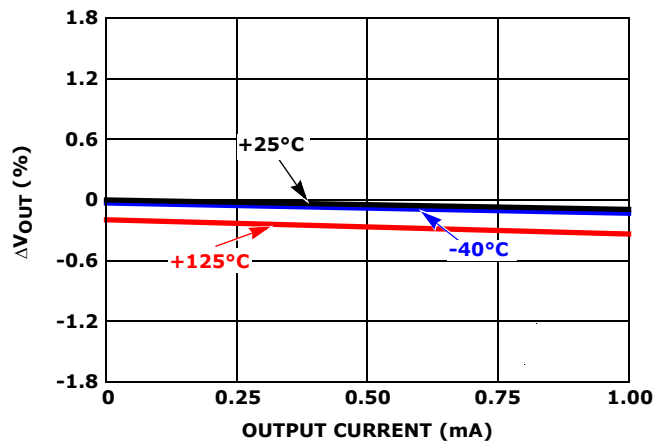

FIGURE 6. OUTPUT VOLTAGE vs LOAD CURRENT

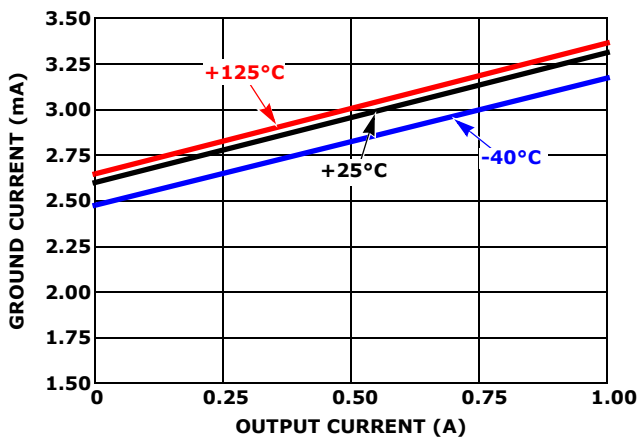

FIGURE 7. GROUND CURRENT vs LOAD CURRENT

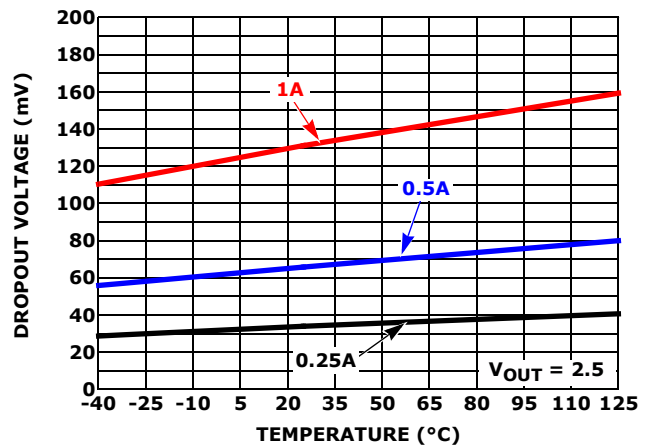

FIGURE 8. DROPOUT AT 1A vs TEMPERATURE

Typical Performance Curves

Unless otherwise specified, $V_{IN} = V_{OUT} + 0.4V$, $V_{OUT} = 1.8V$, $C_{IN} = C_{OUT} = 10\mu F$, $T_J = +25^\circ C$, $I_{LOAD} = 0A$ (Continued)

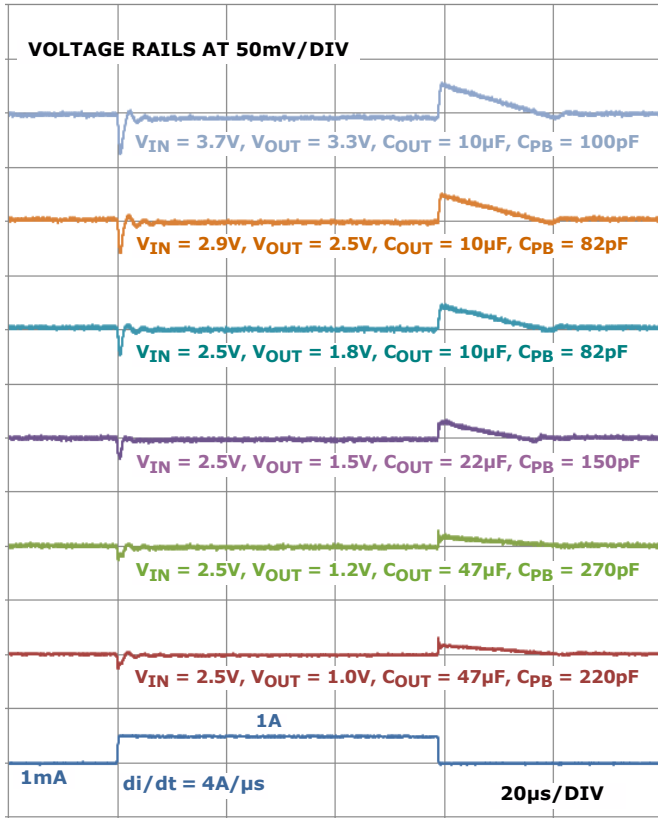

FIGURE 9. LOAD TRANSIENT WAVEFORMS

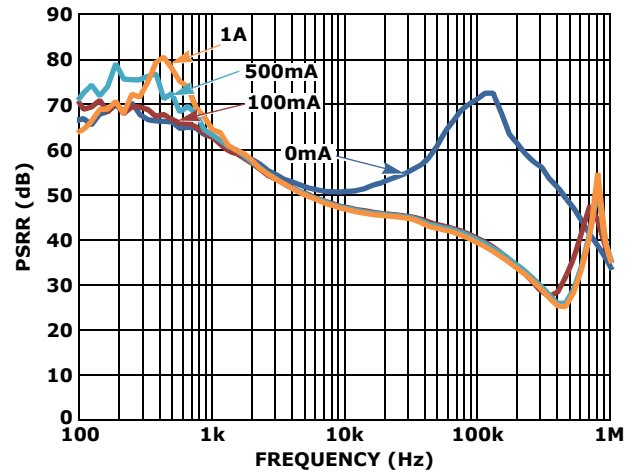

FIGURE 10. $V_{IN} = 2.5V, V_{OUT} = 1.0V, C_{OUT} = 47\mu F, C_{PB} = 220pF$

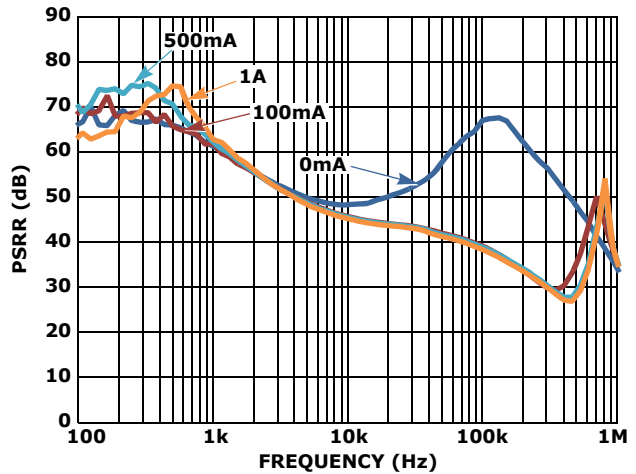

FIGURE 11. $V_{IN} = 2.5V, V_{OUT} = 1.2V, C_{OUT} = 47\mu F, C_{PB} = 270pF$

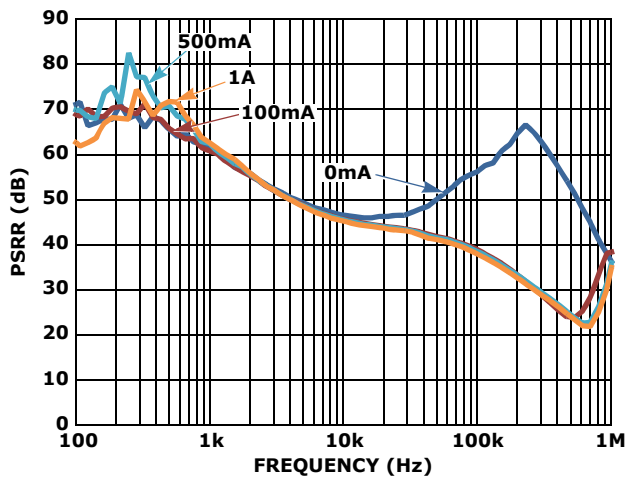

FIGURE 12. $V_{IN} = 2.5V, V_{OUT} = 1.2V, C_{OUT} = 22\mu F, C_{PB} = 120pF$

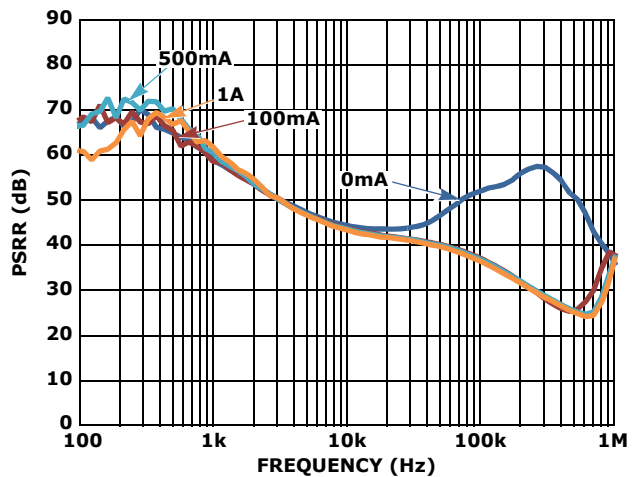

FIGURE 13. $V_{IN} = 2.5V, V_{OUT} = 1.5V, C_{OUT} = 22\mu F, C_{PB} = 150pF$

Typical Performance Curves

Unless otherwise specified, $V_{IN} = V_{OUT} + 0.4V$, $V_{OUT} = 1.8V$,
 $C_{IN} = C_{OUT} = 10\mu F$, $T_J = +25^\circ C$, $I_{LOAD} = 0A$ (Continued)

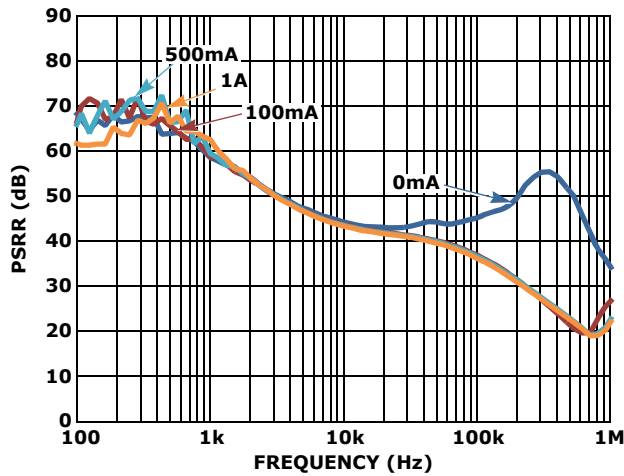

FIGURE 14. $V_{IN} = 2.5V$, $V_{OUT} = 1.5V$, $C_{OUT} = 10\mu F$,
 $C_{PB} = 68pF$

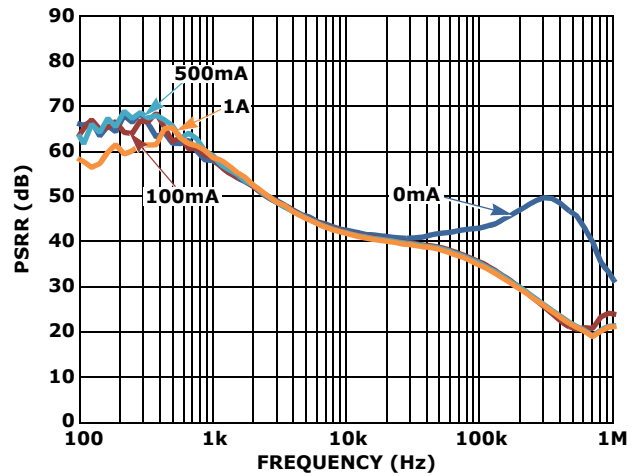

FIGURE 15. $V_{IN} = 2.5V$, $V_{OUT} = 1.8V$, $C_{OUT} = 10\mu F$,
 $C_{PB} = 82pF$

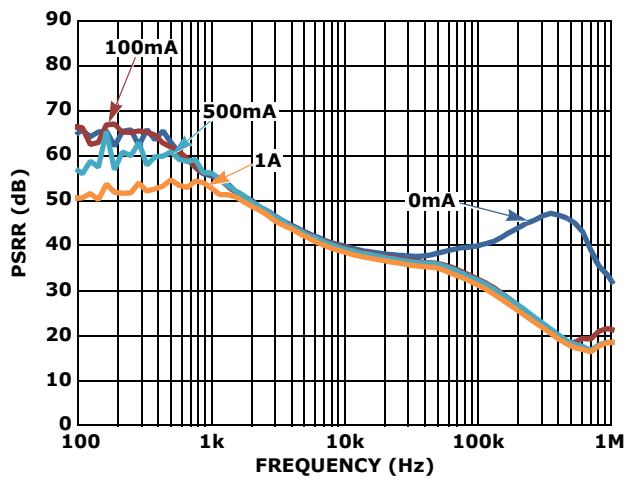

FIGURE 16. $V_{IN} = 2.9V$, $V_{OUT} = 2.5V$, $C_{OUT} = 10\mu F$,
 $C_{PB} = 82pF$

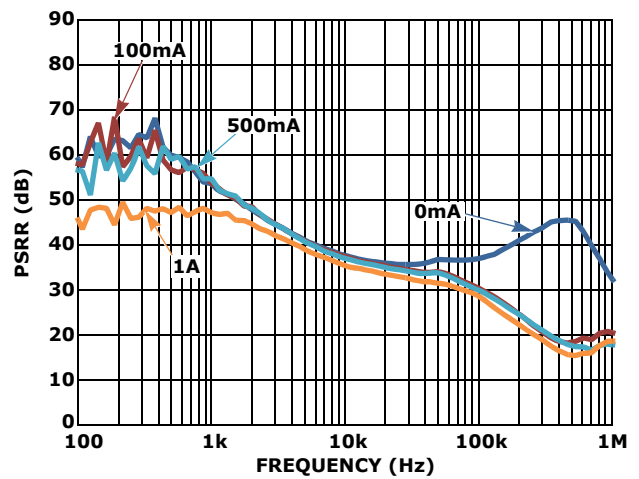
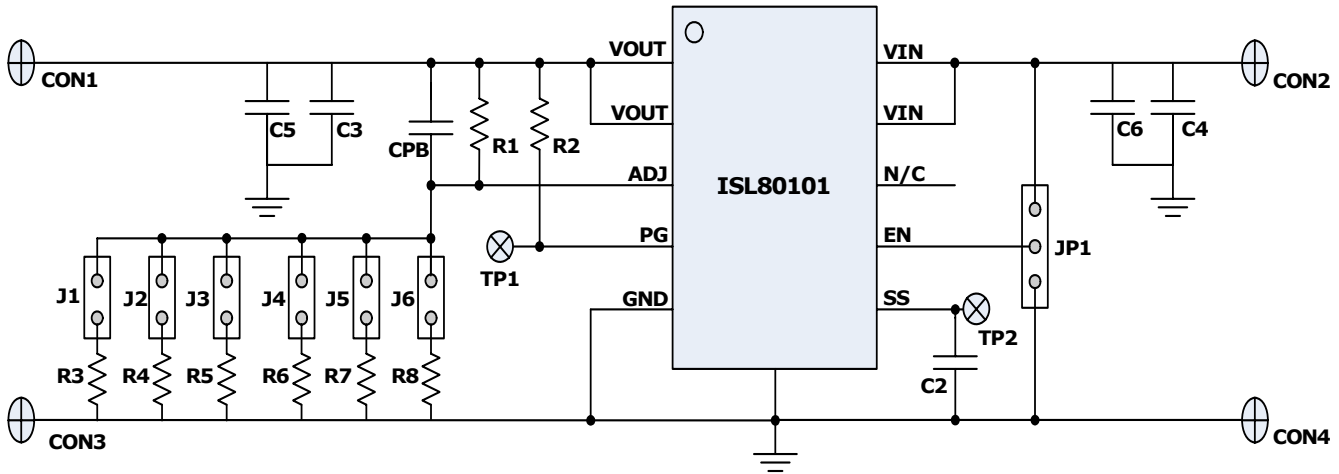

FIGURE 17. $V_{IN} = 3.7V$, $V_{OUT} = 3.3V$, $C_{OUT} = 10\mu F$,
 $C_{PB} = 100pF$

Application Note 1592

Schematic



Bill of Materials

ITEM	QTY	REFERENCE DESIGNATOR	VALUE	DESCRIPTION	MANUFACTURER	PART NUMBER
1	2	C5, C6	10 μ F	CAP, SMD, 0805, 16V, 10%,	Generic	
2	1	CPB	82pF	CAP, SMD, 0603	Generic	
3	1	U1		ISL80101IRAJZ	Intersil	ISL80101IRAJZ
4	1	R1	2.61k Ω	RES, SMD, 0603, 1%	Generic	
5	1	R2	100k Ω	RES, SMD, 0603, 1%	Generic	
6	1	R3	1k Ω	RES, SMD, 0603, 1%	Generic	
7	1	R4	464 Ω	RES, SMD, 0603, 1%	Generic	
8	1	R5	1.3k Ω	RES, SMD, 0603, 1%	Generic	
9	1	R6	1.87k Ω	RES, SMD, 0603, 1%	Generic	
10	1	R7	2.61k Ω	RES, SMD, 0603, 1%	Generic	
11	1	R8	649 Ω	RES, SMD, 0603, 1%	Generic	
12	1	JP1		Jumper	Generic	
13	6	J1, J2, J3, J4, J5, J6		Jumper	Generic	
14	1	TP1		Test Point	Keystone	5007
15	4	CON1, CON2, CON3, CON4		Terminal Connector	Keystone	1514-2
		C2, C3, C4, TP2		DNP		

NOTE: Available fixed versions of the ISL80101 will be sampled in an accompanying kit. Certain fixed versions will be available at a later date.

Intersil Corporation reserves the right to make changes in circuit design, software and/or specifications at any time without notice. Accordingly, the reader is cautioned to verify that the Application Note or Technical Brief is current before proceeding.

For information regarding Intersil Corporation and its products, see www.intersil.com

ISL80101EVAL2Z Evaluation Board Layout

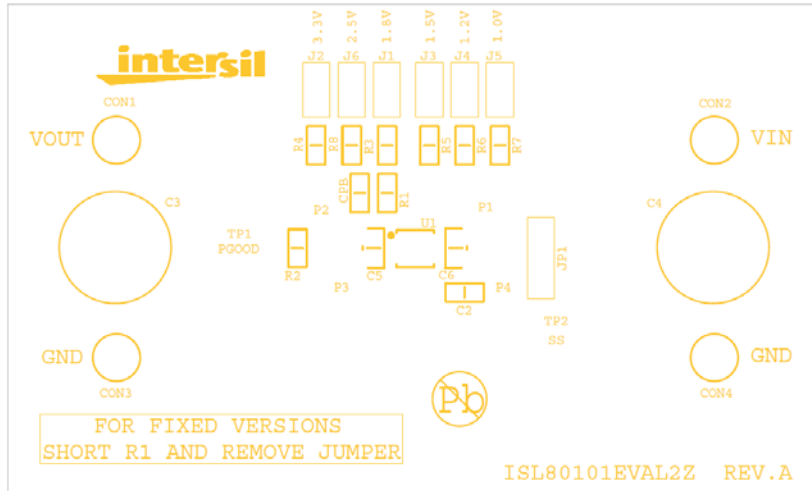

FIGURE 18. ISL80101EVAL2Z COMPONENT PLACEMENT

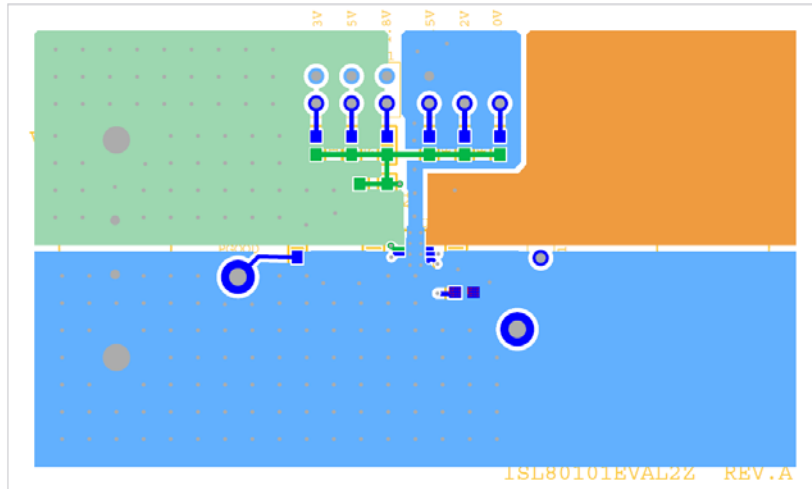

FIGURE 19. ISL80101EVAL2Z TOP LAYER

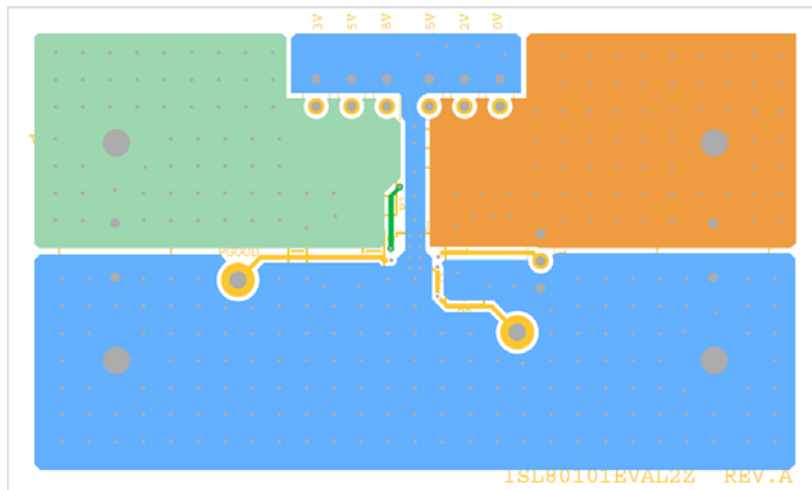

FIGURE 20. ISL80101EVAL2Z BOTTOM LAYER